

VS-050 (Rear Connector Panel, Standard Flange, Protected type(IP67))
 410590-3330
 VS-050 (Rear Connector Panel, Standard Flange, Dust & Mistproof (IP54(Wrist:IP65)))
 410590-3450

Detailed drawing of end-effector mounting face

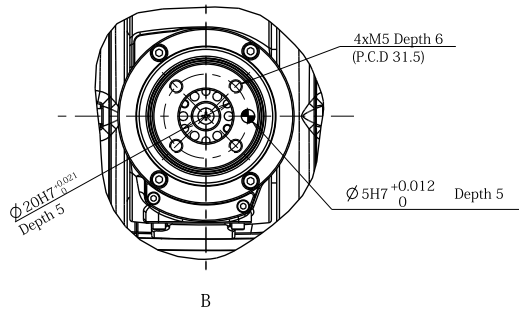

Detailed drawing of base mounting face

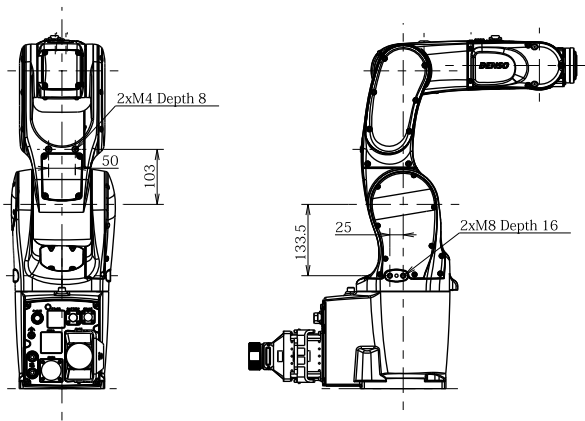
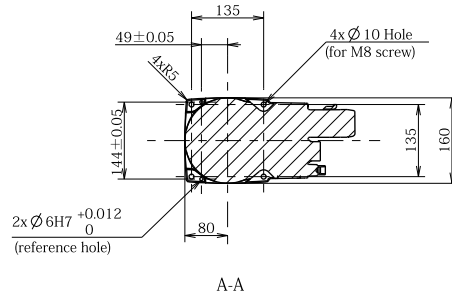

Workable space
 defin by point P

